

deem media



Hybrid meetings create new demands on technology and environment. At the same time, agile teams are taking control of their work environment and organize themselves, as their work requires.

The need for mobile and visually supportive media is increasing and goes hand in hand with the ever-growing desire to disconnect from fixed meeting rooms.

deem media takes this trend into account and is a mobile piece of furniture for video conferencing and digital presentation space.

The media furniture, which is very intuitive to use, visually very slim and homely, is designed to accommodate monitors of up to 65 inches and a wide variety of other media technology solutions.

Thanks to an ingenious combination of different roller systems, deem media can be moved around the room with ease. The central placement and the concealed castors avoid tripping hazards caused by foot stabilizers, which once again distinguishes the ophelis product novelty.

The storage space at the rear blends in with the design language is equipped with ventilation slots and offers lockable space for the technology to be integrated.

Electrification is provided by cable outlets on the side, optionally with cable sock or by a helical cable with a hook.

deem media is prepared to accommodate screens, which are provided and mounted by the user. The choice of textiles and surfaces, including whiteboard surfaces, deprives ophelis deem media of its technical appearance



Product features

- Integration of monitors up to 65 inch
- Flexible positioning in the room
- Concealed smooth-running roller system for easy movement through the room
- No lateral tripping hazards
- Storage space for technology at the back
- Electrification through lateral cable outlets
- Optionally with cable sock or spiral cable with hooks
- Individual design through choice of textiles and surfaces

Dimensions

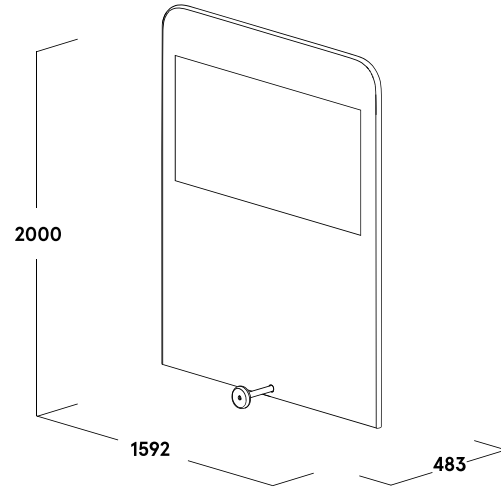
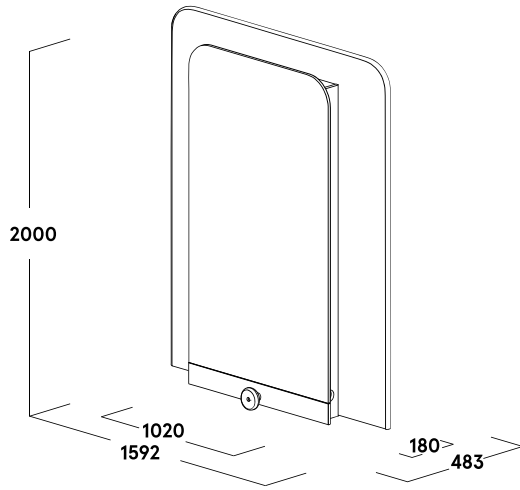

Colors and materials

Fabric: Camira Carlow (PG 20)

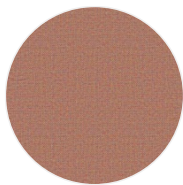

CLW06



CLW04

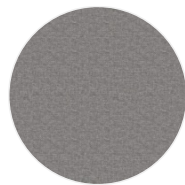

CLW01

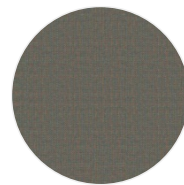

CLW17

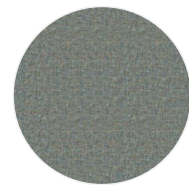

CLW09

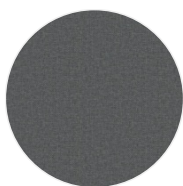

CLW23

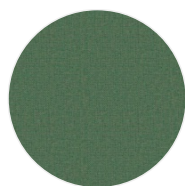

CLW20

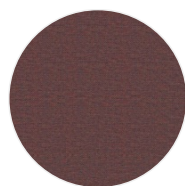

CLW08

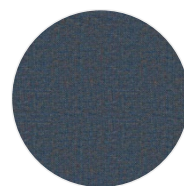

CLW12

Fabric: Kvadrat Remix Screen



0688



0408



0528

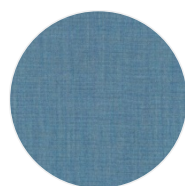

0818



0998



0128



0138

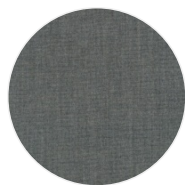

0148



0158



0188



0228



0288



0328



0358

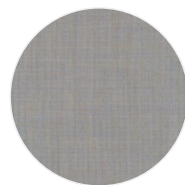

0608

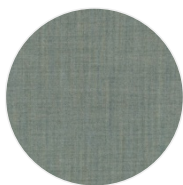

0908

Fabric: Camira Synergy 170

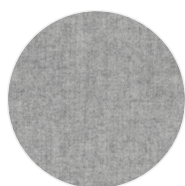

LDP08

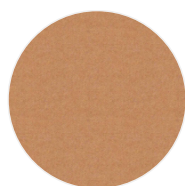

LDP18



LDP20

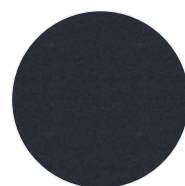

LDP25



LDP32

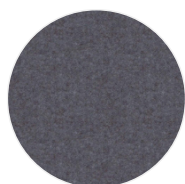

LDP35



LDP45

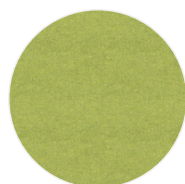

LDP46



LDP49

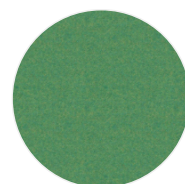

LDP53

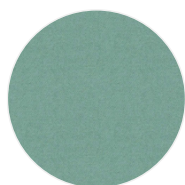

LDP54

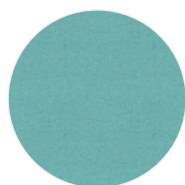

LDP55

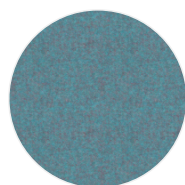

LDP56

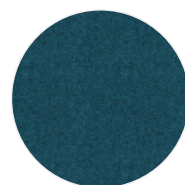

LDP59

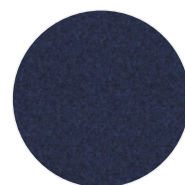

LDP62

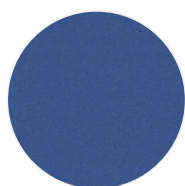

LDP63

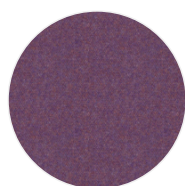

LDP66

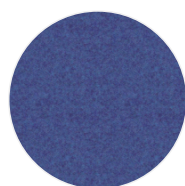

LDP68



LDP69

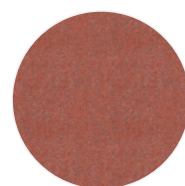

LDP73



LDP77

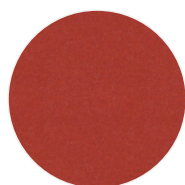

LDP84



LDP85

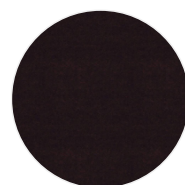

LDP88

Surfaces: Genuine wood



maple



maple, oiled



whitewashed
oak



whitewashed
oak, oiled



oak



oak, oiled



beech



cherry wood

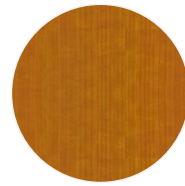

cherry wood,
oiled



walnut



walnut, oiled



smoked oak



black oak

Surfaces: Melamine



atlas white



cream white



soft white



light grey

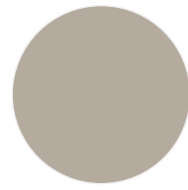

Silk grey

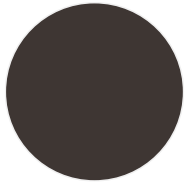

grey brown

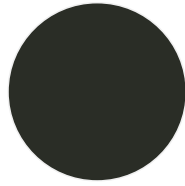

graphite

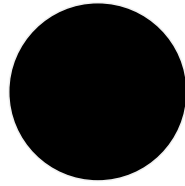

black



maple trim



oak light

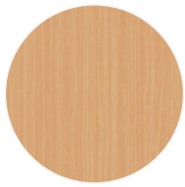

beech light

Surfaces: lacquer



traffic white
(RAL 9016)



cream white
(RAL 9001)



silk grey
(RAL 7044)

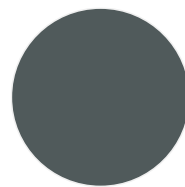

iron grey
(RAL 7011)

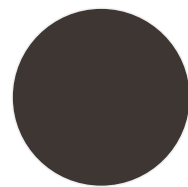

grey brown
(RAL 8019)



pale green

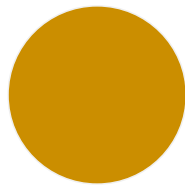

Honey yellow
(RAL 1005)

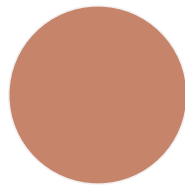

beige red
(RAL 3012)

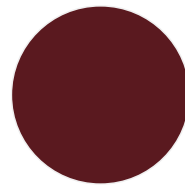

wine red
(RAL 3005)

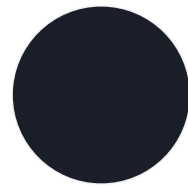

black blue
(RAL 5004)

Planning data

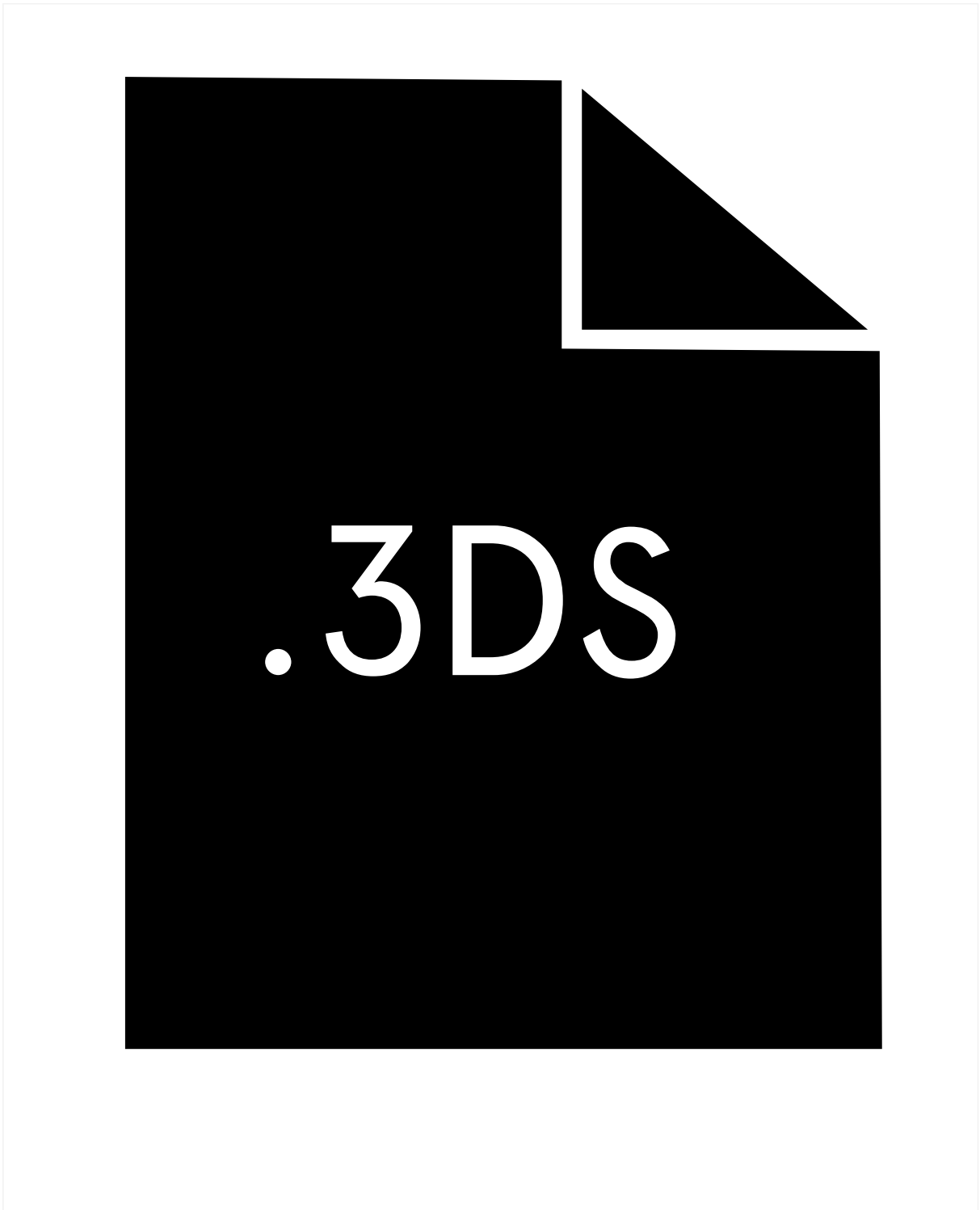

ophelis deem media 3DS

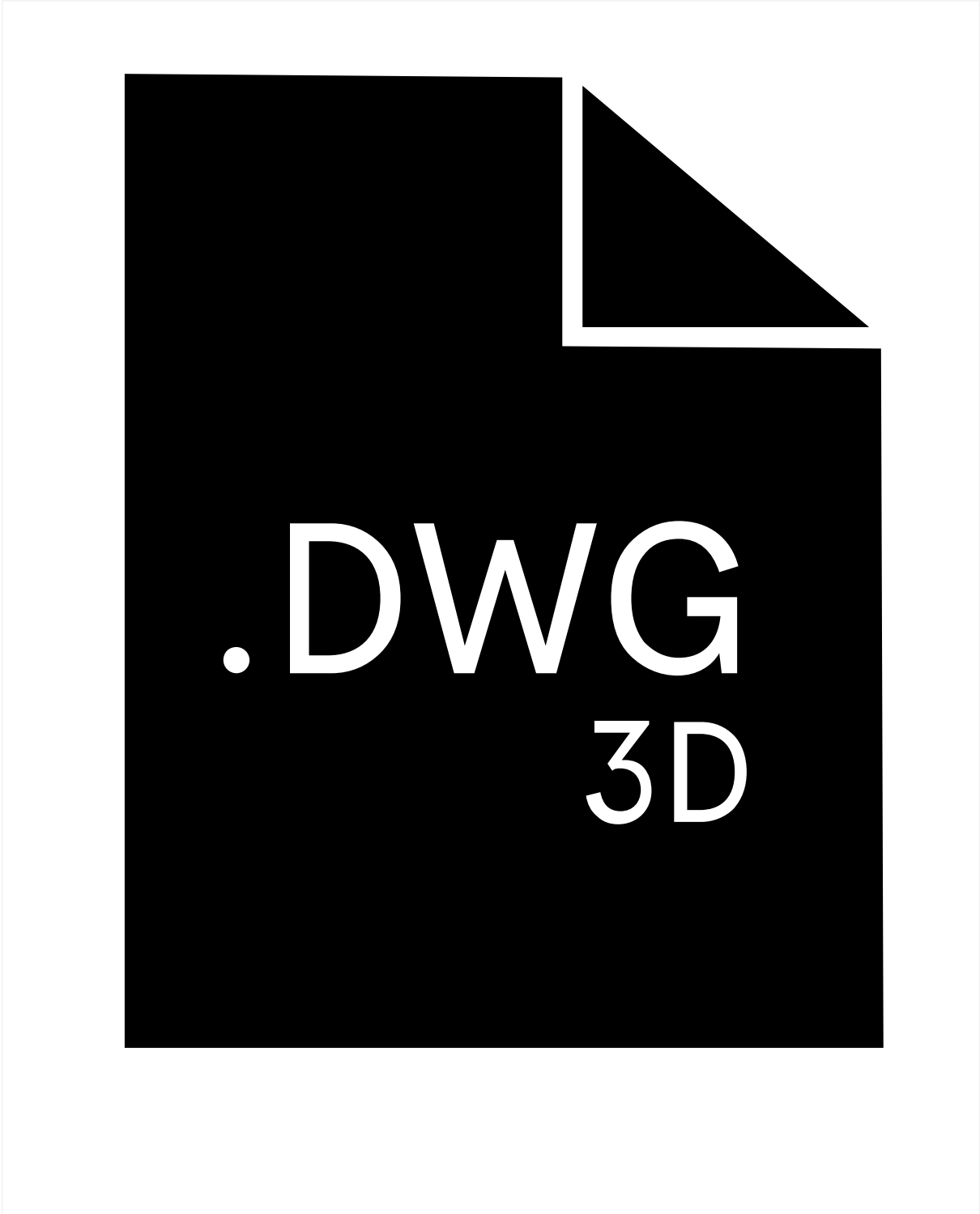

ophelis deem media DWG 3D



.DWG
2D

ophelis deem media DWG 2D

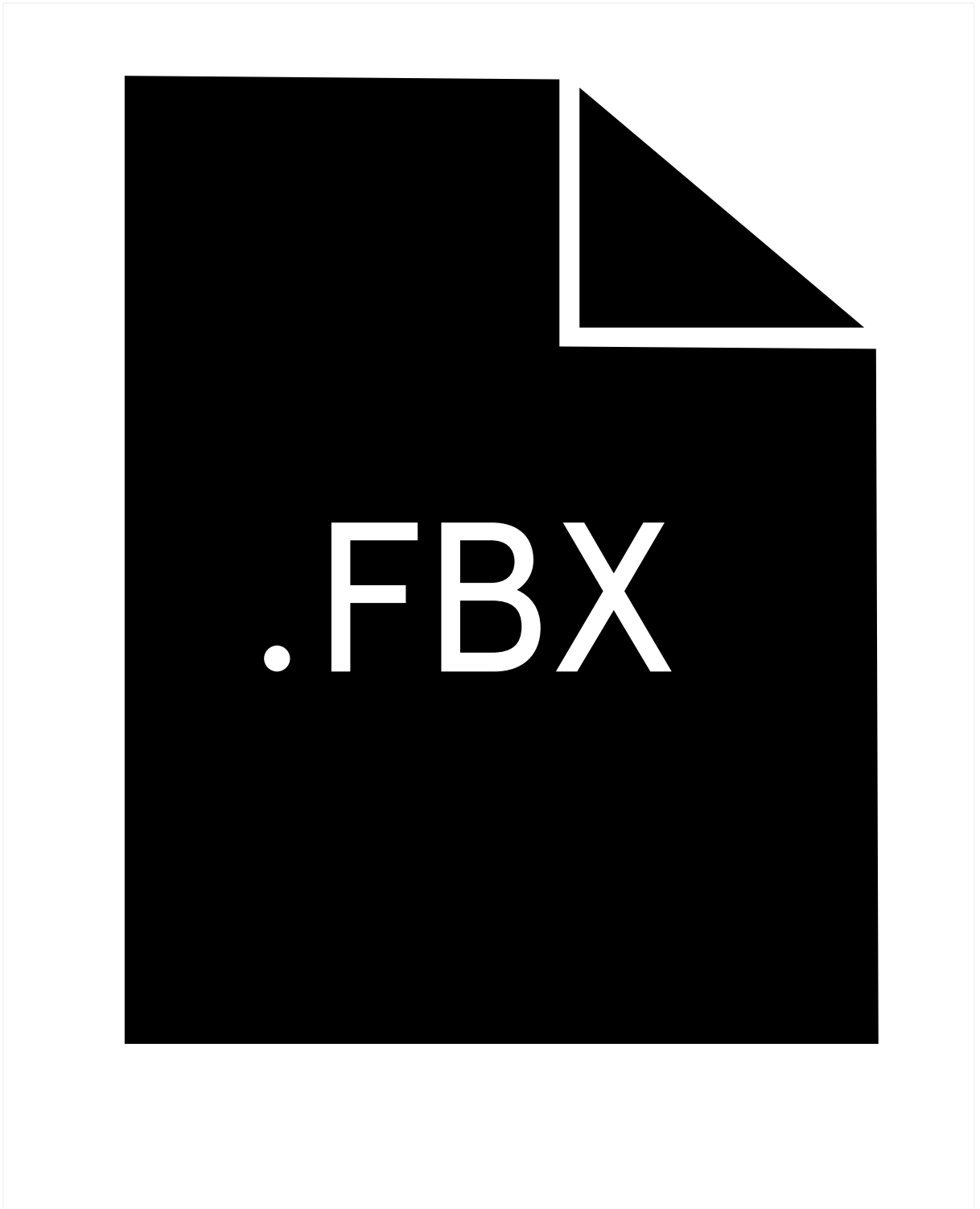

ophelis deem media FBX

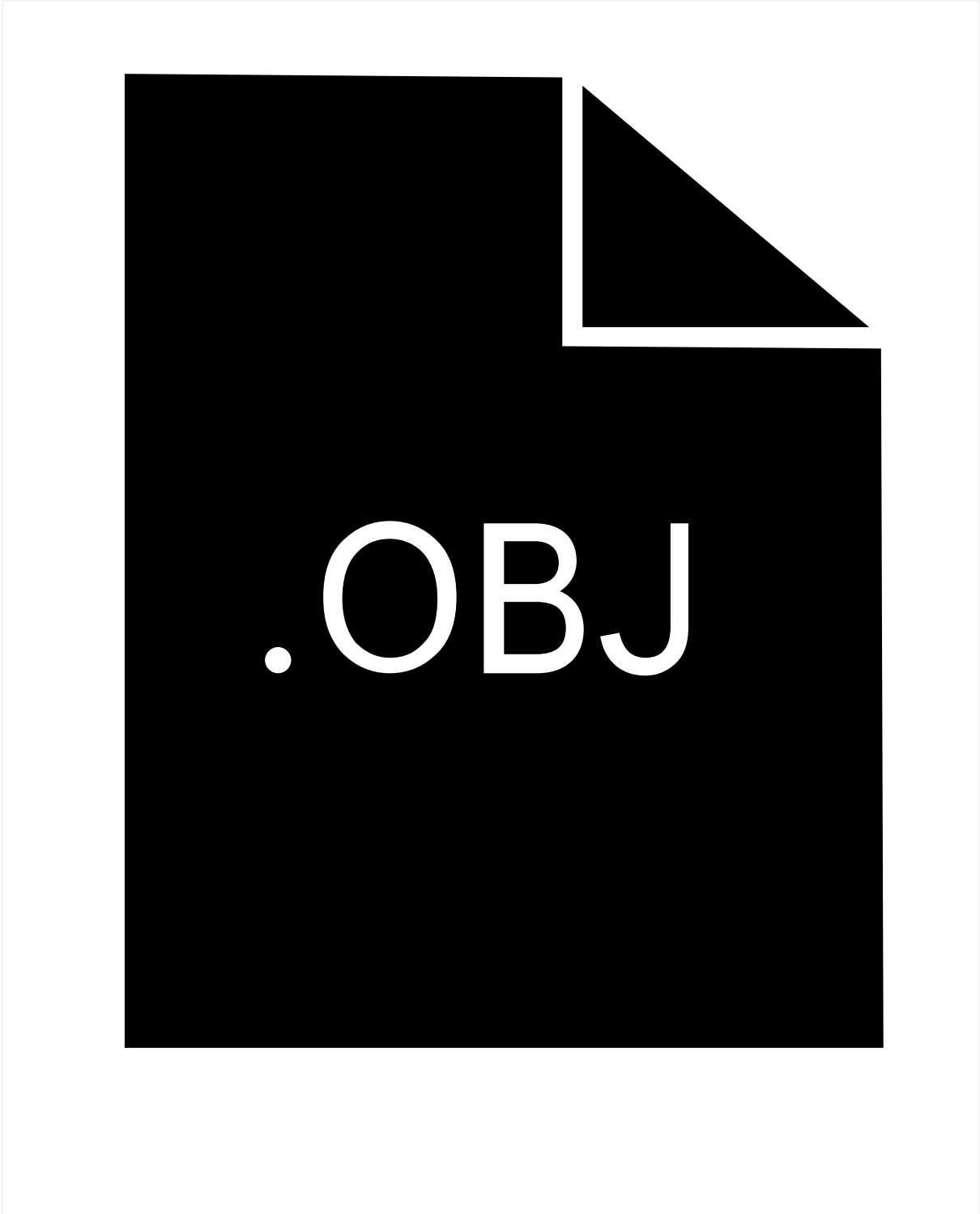

ophelis deem media OBJ

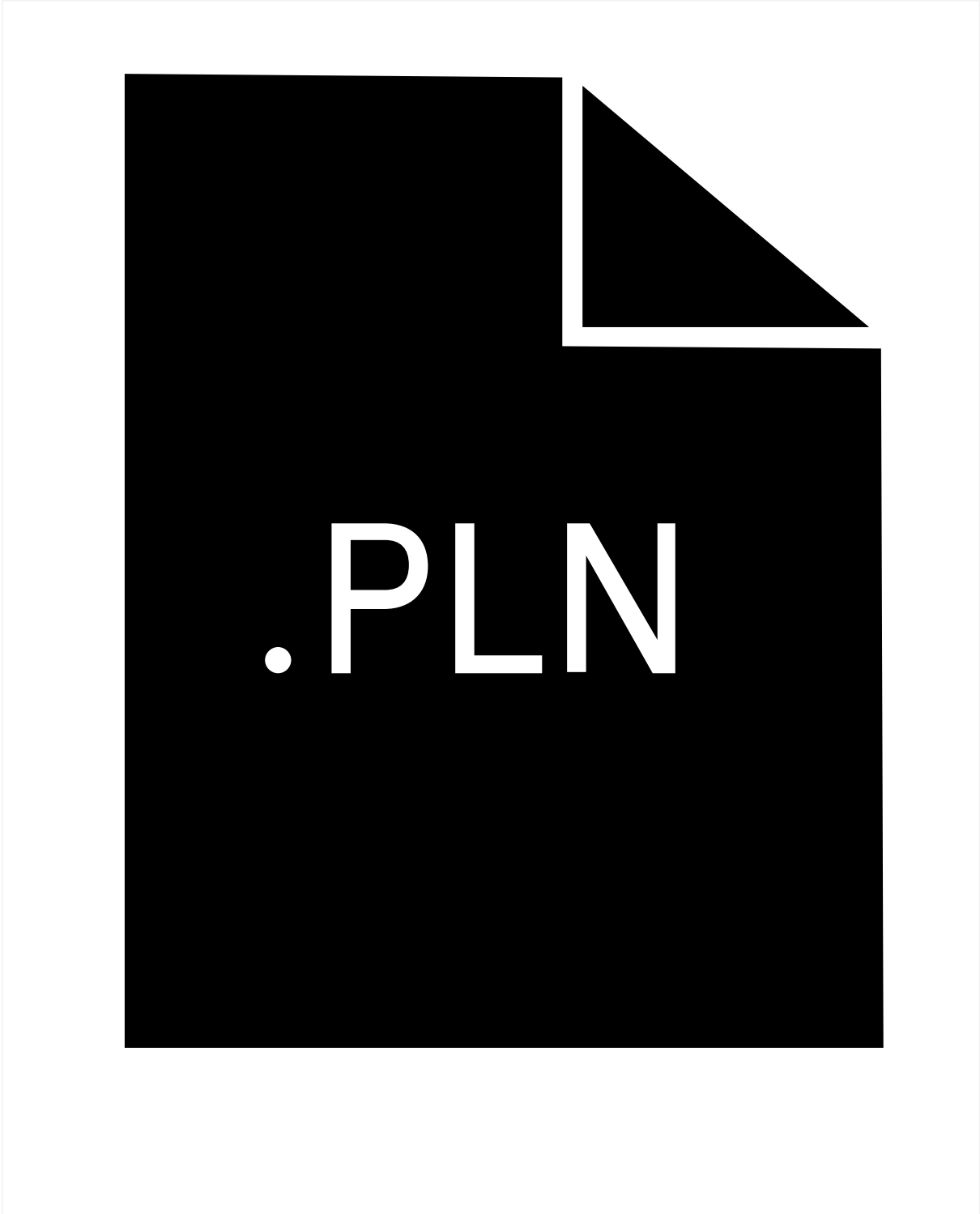

ophelis deem media PLN

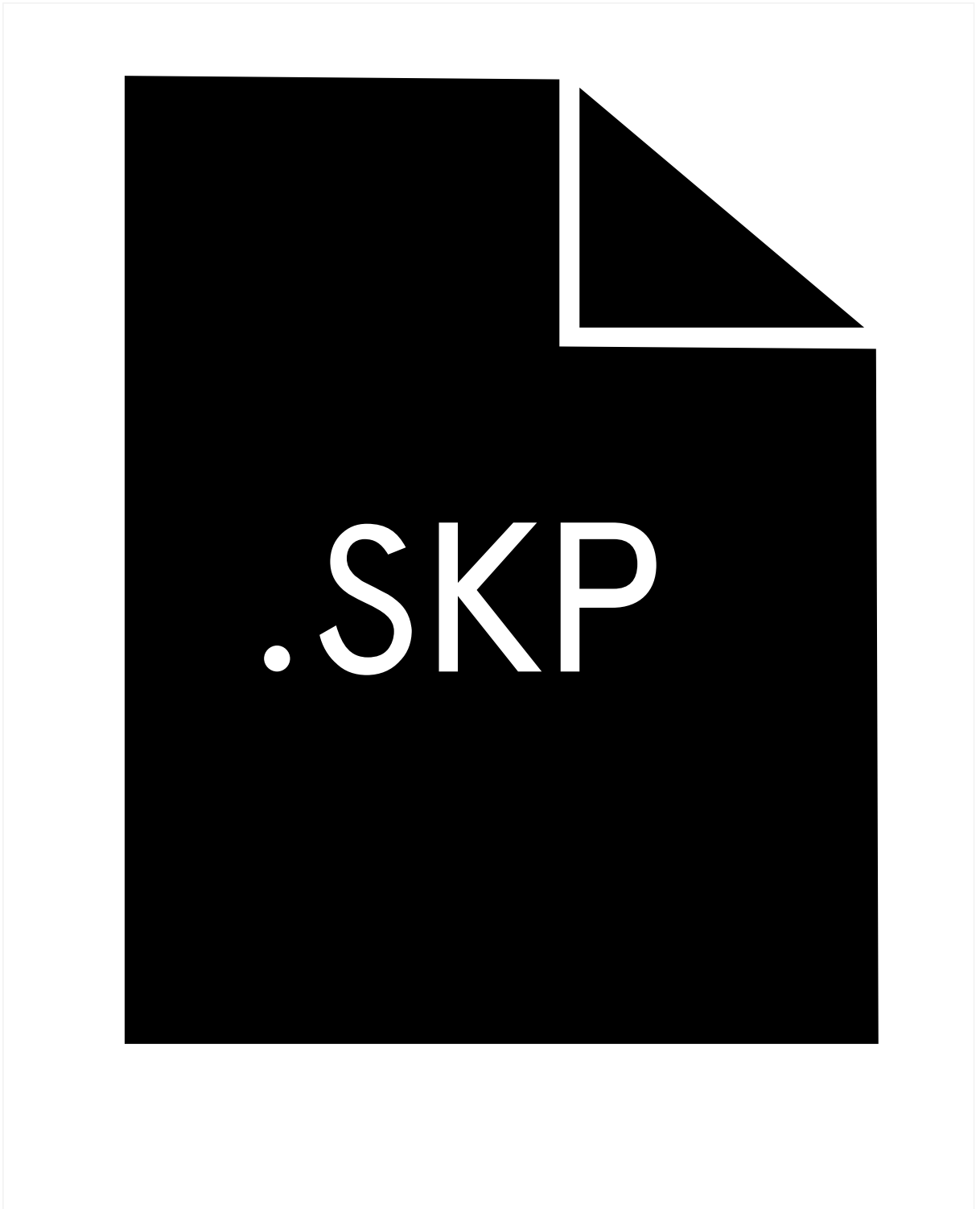

ophelis deem media SKP

Der rückseitige Stauraum fügt sich in die Formensprache ein, ist mit Lüftungsschlitzen ausgestattet und bietet abschließbaren Raum für die zu integrierende Technik.

Die Elektrifizierung erfolgt durch seitliche Kabelauslässe, optional mit Kabelstrumpf oder durch eine Wendelleitung mit Haken.

deem media ist vorbereitet für die Aufnahme von Screens, die nutzerseits bereitgestellt und montiert werden. Durch die Auswahl der Textilien- und Oberflächen inkl. Whiteboardoberflächen wird **ophelis deem media** die technische Anmutung genommen.

